

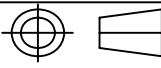

ECO.NO	ZONE	DETAILS	DESIGN	DATE
00159				2010-3-10
S19004		删除 "Printed in China"		2019-4-19

Notes:

1. Material: 80g printing paper, white.size 290*210MM.
2. Printing: Black
3. Pack and tie a label with part number 0-ML00-0017-02-1.

	 青嶸科技有限公司 A&R Technologies Ltd.							
	DIMENSION TOLERANCES UNLESS OTHERWISE SPECIFIED		CLIENT	PART NAME		英文版说明书		
	>0.0AND≤5	+/-0.055mm	MOULD NO	SP-112PI	PART NO		0-ML00-0017-02-1	
	>5AND≤10	+/-0.060mm	MATERIAL	REV	2	DESIGN	范绮玲	DATE
	>10AND≤25	+/-0.075mm	SIZE	/	SCALE	/	CHECK	DATE
	>25AND≤50	+/-0.100mm	SHEET	UNIT	mm	APPROVAL	DATE	
>50AND≤100	+/-0.150mm							
>100AND≤150	+/-0.200mm							
>150	+/-0.250mm							
Angular	+/-0.25°							

SP-112PI PYROFLEX™ Motion Sensor

Operation and Specifications

SUREN

The SP-112PI is a professional state-of-the art motion sensor engineered with the world's best components and materials. Special analog stealth circuitry provides microcontroller-grade intruder detection at the lowest cost. The circuitry includes innovative HighBar™ processing for false alarm rejection better than most ASIC-based methods. In addition, patented PYROFLEX™ IR detection provides much stronger intrusion signals than conventional detectors, so the processor easily tells real intrusions from false alarms.

SENSOR INITIALIZATION

Following power-on, a SP-112PI sensor is fully operational after a one-minute warm-up.

WALK TEST

Note: The SP-112PI should be tested once per year.

Enable the LED (JP1 ON). If the LED is not enabled, then, without removing power, set JP1 to ON. Walk across the monitored area (within the sensor's optical fields-of-view). With sensitivity set at STANDARD, the LED should turn ON (for Alarm) after about three to five normal steps. With the sensitivity set at HIGH, the LED should turn ON (for Alarm) after about two to four normal steps. Each time the LED turns ON, wait for it to turn OFF. Then, wait 12 seconds before continuing the walk-test. When there is no motion in the monitored area, the LED should remain OFF.

ALARM PROCESSING

Dual-element detector fields-of-view alternate between (+) and (-) polarity. HighBar™-qualified signal events are counted as "pulses" exclusively when polarity alternates. Depending on sensitivity setting, (+,-), (-,+), (+,-,+) or (-,+,-) will cause an alarm.

PET IMMUNITY

The SP-112PI is designed to allow the presence of pets (10kg or lighter) without signaling an alarm. It includes a special micro-element lens array that produces much stronger optical signals for humans than for pets 10kg or lighter. Furthermore, the optical sensitivity of each SP-112PI is factory-calibrated to ensure accurate discrimination between humans and pets.

NOTE: Pets come in many varieties. Some pets (especially larger ones with very short hair), even if lighter than 10kg, may produce enough infrared radiation to cause alarms. SP-112PI users are strongly advised to test the sensor with their own pets, in order to verify that the SP-112PI will not signal an alarm when their pets are moving within its fields of view.

The diagram below shows the SP-112PI's zones of greatest human/pet discrimination. The SP-112PI should be mounted so that pets will occupy only the lighter-colored spaces.

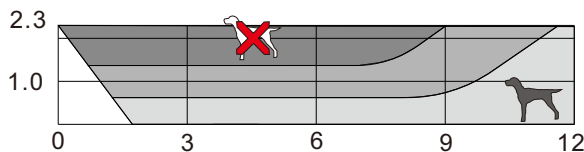

SPECIFICATIONS

Range: 12 meters in sensor-facing direction
12 meters at 45° angle from sensor-facing direction

Sensor Optical View Pattern (side view, in meters)

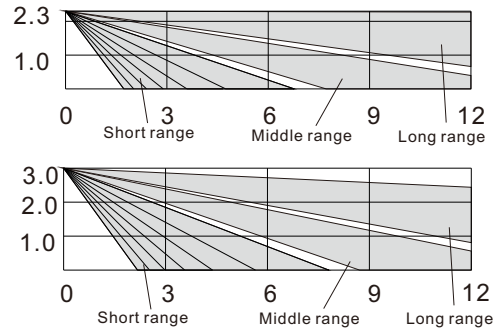

Optical Fields-of-View:

Long-range	Mid-range	Short-range
44	36	18

Sensor Optical View Pattern (top view, in meters)

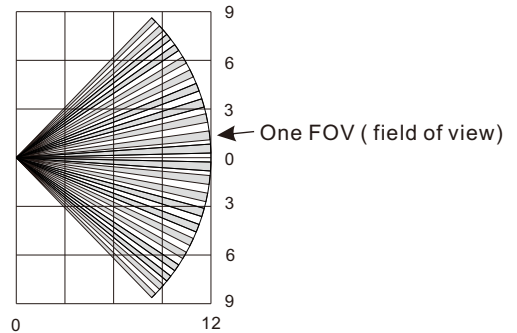

IR Sensor:
PYROFLEX™, Dual elements

Power Supply:
8-16 Vdc; 15 mA at 12 Vdc

Alarm Relay:
Reed, form A(NC), 50mA at 30 Vdc.

Tamper Switch:
Form A (NC). 50 mA at 30 Vdc

Housing Material:
High-impact ABS

Dimensions:
94 x 50 x 42 mm (H x W x D)

Approvals/qualification:



Complies with:
EN 50131-2-2 Grade 2, Class II

Events Detection:
HighBar™ false alarm rejection processor

RF Immunity:
20 V/m, 10-1000 MHz;
10 V/m, 1-2 GHz

White Light Immunity:
6500 lux

Sensitivity:
Selectable: 2-event or 3-event

Operating Temperature Range:
-10°C to +55°C

Accessories:
Mounting bracket:
MB-100

Note: Specifications are subject to change without notice.

Limitations of Security Products: Security products and alarm systems do not offer guaranteed protection against burglary, fire, or other emergencies. They may fail to warn for diverse reasons, including (but not limited to): power failure, dead batteries, improper installation, coverage "blind spots", coverage areas overlooked during installation, defeat by technically sophisticated intruders, component failure, or inadequate maintenance. Alarm systems should be checked weekly to ensure that all devices are working properly. AN ALARM SYSTEM IS NOT A SUBSTITUTE FOR INSURANCE.

SUREN LIMITED WARRANTY

SUREN Systems, Ltd., of Fo Tan, Shatin, Hong Kong, warrants its products to be in conformance with its own plans and specifications and to be free from defects in materials and workmanship under normal use and service for twelve months from the date of original purchase. Seller's obligation shall be limited to repairing or replacing, at its option, free of charge for materials or labor, any part which is proved not in compliance with Seller's specifications or proves defective in materials or workmanship under normal use and service. Seller shall have no obligation under this Limited Warranty or otherwise if the product is altered or improperly repaired or serviced by anyone other than Seller. For warranty service, return transportation prepaid, to SUREN Systems, Ltd., Unit 15, 12/F, Block B, Wah Sang Industrial Building, 14-18 Wong Chuk Yeung Street, Fo Tan, Shatin, Hong Kong. Seller has no obligation to attend the buyer's location to retrieve the goods or make repairs on site.

There are no warranties, expressed or implied, of merchantability, or fitness for a particular purpose or otherwise, which extend beyond the description on the face hereof. In no case shall seller be liable to anyone

for any consequential or incidental damages for breach of this or any other warranty, express or implied, or upon any other basis of liability whatsoever, even if the loss or damage is caused by its own negligence or fault.

Seller does not represent that the products it sells may not be compromised or circumvented; that the products will prevent any personal injury or property loss by burglary, robbery, fire or otherwise; or that the products will in all cases provide adequate warning or protection. Customer understands that a property installed and maintained alarm system may only reduce the risk of a burglary, robbery, or fire without warning, but it is not insurance or a guarantee that such will not occur or that there will be no personal injury or property loss as a result.

Consequently, seller shall have no liability for any personal injury, property damage or other loss based on a claim the product failed to give any warning. However, if seller is held liable, whether directly or indirectly, for any loss or damage arising under this limited warranty or otherwise, regardless of cause or origin, seller's maximum liability shall not in any case exceed the purchase price of the product, which shall be the complete and exclusive remedy against seller.

This warranty replaces any previous warranties and is the only warranty made by Seller on this product. No increase or alteration, written or verbal, of the obligations of this Limited Warranty is authorized.

Patents issued and pending worldwide.
Patent information at www.surensys.com.

U.S. Patent NO: 7,042,134 7,141,910
U.K. Patent NO: GB 2 427 270 Patents pending

SP-112PI Installation Instructions

1: Mounting Location

A. Wall mounting:

1. Sensor base fastened flat on vertical wall (± 2 degrees)

B. Bracket mounting:

1. Bracket fastened to semi-vertical surface (± 15 degrees)
2. Sensor on bracket in vertical position (± 2 degrees)

C. All mounting:

1. Height = 2.3 m or 3m above floor of monitored area
2. Clear line-of-sight from sensor to monitored area
Note: glass will block sensor's view.
3. Wall temperature similar to walls/floor of monitored area
4. Sensor aimed away from windows and reflected sunlight
5. Sensor aimed away from heaters or heater/cooler outlets
6. Sensor aimed so that likely intruder paths cross three views

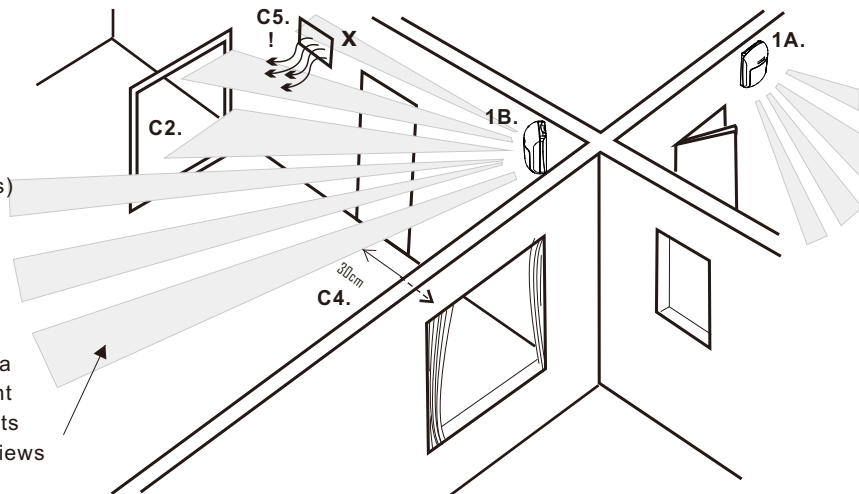

2: Sensor Disassembly

In slot at sensor bottom, use screwdriver or thumbnail to push inward (1.) on cover latch. (2.) Remove cover. (3.) Push outward on circuit board latch at sensor base right side. Using circuit board terminal block as handle, gently lift circuit board right side and remove.

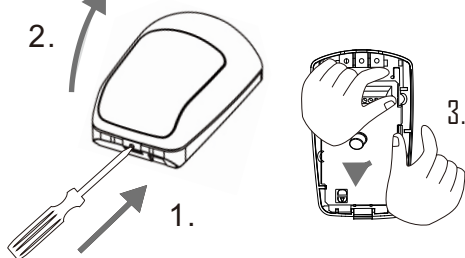

3: Base Hole Preparation

Identify necessary holes on diagram;
 1. For wall mounting, knock out hole covers.
 2. For corner or 45 degree wall mounting, use drill to open at least two holes at base side depressions.
 3. For bracket mounting, use drill to open a 3 mm hole in the center of the square recess at the rear of the base. See 6 for more.
 If cable ties will be added for wire strain relief, select holes needed, then clear out thin plastic material covering those holes.

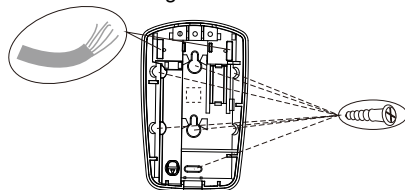

4: Cable Preparation

Remove 8 cm of cable jacket. Pass the cable wires through the selected hole. Lay cable in wire channel. Secure cable with cable tie.

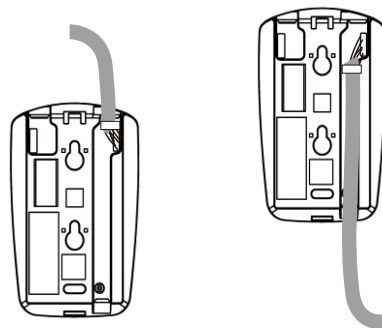

5: Wall Mounting

Use screws to mount on wall or in corner.

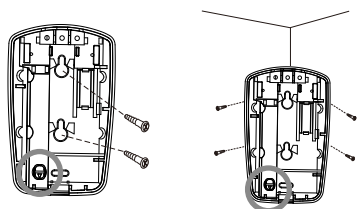

Set circuit board alignment post in position "0" or "1" to select mounting height.

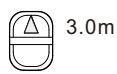
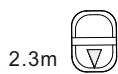

2.3m
Alignment Post position "0"
Use with:
Wide-angle lens.

3.0m
Alignment Post position "1"
Use with:
Wide-angle lens

6: Bracket Mounting

Use screws to mount bracket in desired location. Use screw to mount sensor base onto bracket. Refer to 5 for setting circuit board alignment post.

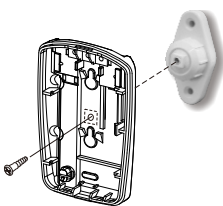

7: Circuit Board Installation

To replace circuit board, (1.) place circuit board left edge into two left-hand mounting slots in sensor base. (2.) On right-hand side, gently press circuit board into place until latch snaps over circuit board. Cut cable wires to appropriate length and connect wires to sensor terminal block.

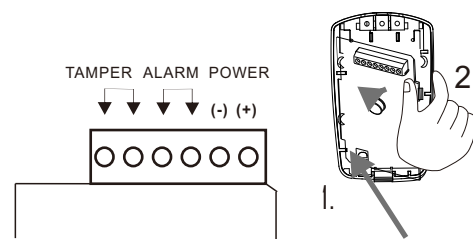

8: Operation Programming

Set JP1 and JP2 according to need. If there is a way for intruders to pass only a very short distance in the sensor's view, or if aggressive detection is required, then use high sensitivity. Otherwise, standard sensitivity is fine for ordinary applications. Factory-set jumper positions are shown below in gray. Pulse counts: High=2; Standard=3.

9: Motion Distance Sensitivity

With standard sensitivity, detection occurs in 3 to 5 steps. With high sensitivity, detection occurs in 2 to 4 steps.

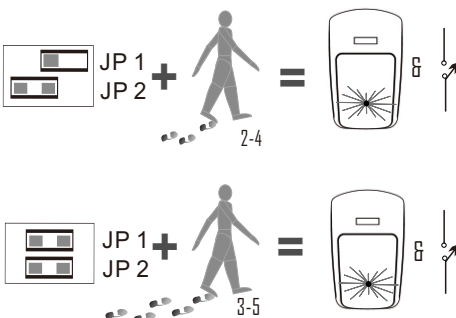

10: LED Indicator Operation

The chart below shows possible LED indications.

SP-112PI			
FUNCTION	JP	ON	OFF
SENSITIVITY	2	STANDARD	HIGH
LED ENABLE	1	ENABLE	DISABLE

SP-112PI	
Sensor State	LED Display
Warm-up	OFF
Alarm	ON 3-6 Sconds (IF LED ENABLED)
Normal	OFF